

HIT photovoltaic module

HIP-225HDE1 HIP-220HDE1 HIP-215HDE1

The SANYO HIT (Heterojunction with Intrinsic Thin layer) solar cell is made of a thin mono crystalline silicon wafer surrounded by ultra-thin amorphous silicon layers. This product provides the industry's leading performance and value using state-of-the-art manufacturing techniques.

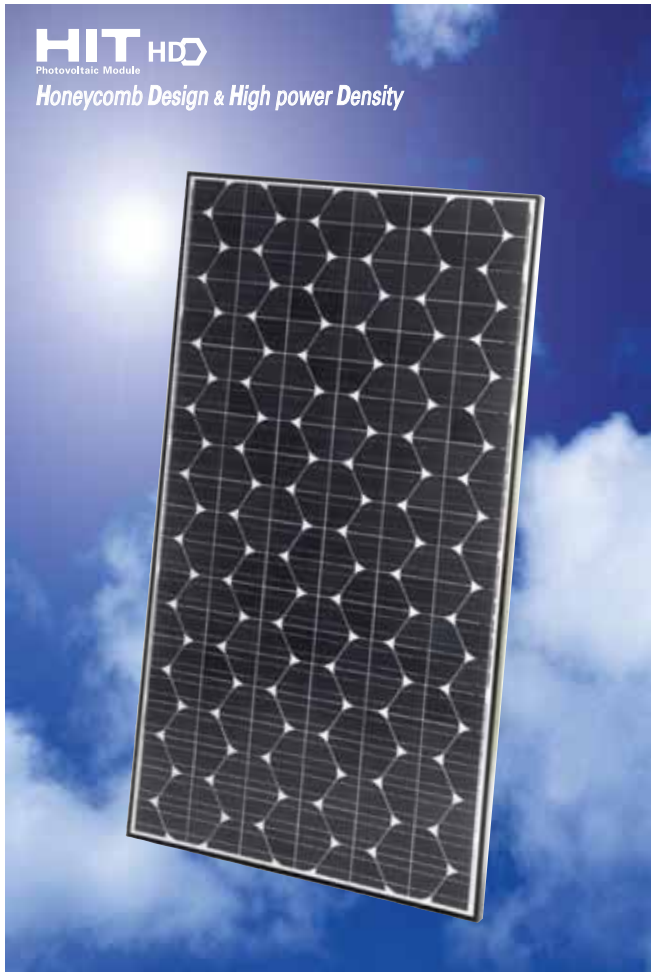

Benefit in Terms of Performance

The HIT cell and module have very high conversion efficiency in mass production.

Model	Cell Efficiency	Module Efficiency
HIP-225HDE1	18.8%	16.2%
HIP-220HDE1	18.3%	15.9%
HIP-215HDE1	17.9%	15.5%

High performance at high temperatures

Even at high temperatures, the HIT solar cell can maintain higher efficiency than a conventional crystalline silicon solar cell.

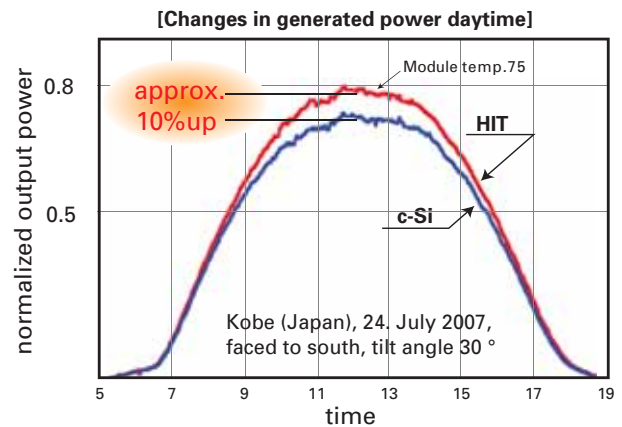

Environmentally-Friendly Solar Cell More Clean Energy

HIT can generate more clean Energy than other conventional crystalline solar cells.

A module which uses silicon resources effectively

The newly developed "Honeycomb Design" HD cell allows the maximum number of round-type, high-power cells to be arrayed in a single module.

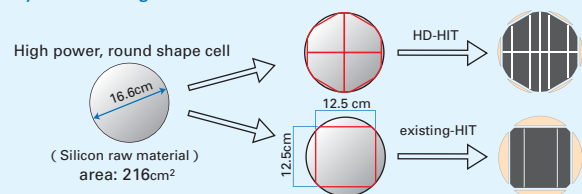

HIT Solar Cell Structure

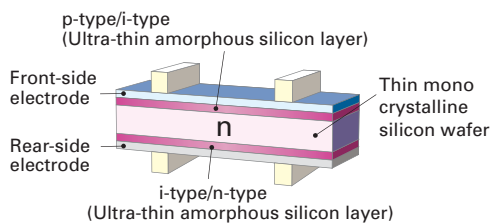

Development of HIT solar cell was supported in part by the New Energy and Industrial Technology Development Organization (NEDO).

Models HIP-xxxHDE1				
Electrical data		225	220	215
Maximum power (Pmax)	[W]	225	220	215
Max. power voltage (Vmp)	[V]	33.9	33.5	33.1
Max. power current (Imp)	[A]	6.64	6.57	6.50
Open circuit voltage (Voc)	[V]	41.8	41.4	40.9
Short circuit current (Isc)	[A]	7.14	7.07	6.99
Warranted minimum power (Pmin)	[W]	213.75	209	204.25
Maximum over current rating	[A]	15		
Output power tolerance	[%]	+10/-5		
Maximum system voltage	[Vdc]	1000		
Temperature coefficient of Pmax	[%/°C]	-0.3		
	Voc [V/°C]	-0.105	-0.104	-0.102
	Isc [mA/°C]	2.14	2.12	2.10

Note 1: Standard Test Conditions: Air mass 1.5, Irradiance = 1000W/m², Cell temperature = 25°C
 Note 2: The values in the above table are nominal

Reference data for model HIP-225HDE1

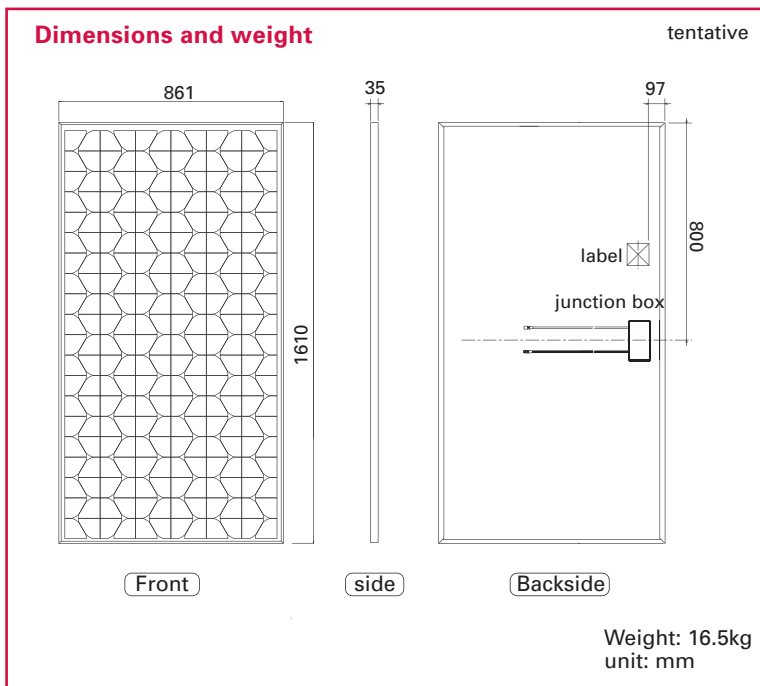
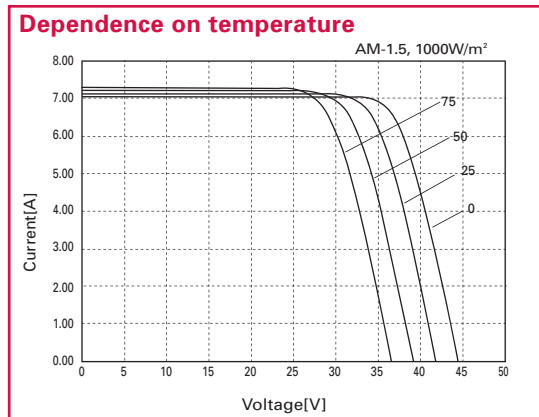
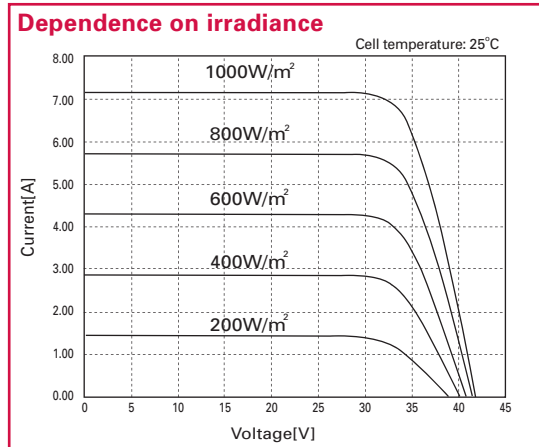

Certificates

Under process of certificate IEC61730

Please consult your local dealer for more information.

CAUTION! Please read the operating instructions carefully before using the products.

Due to our policy of continual improvement the products covered by this brochure may be changed without notice.

SANYO Component Europe GmbH
Clean Energy Division



SANYO Electric Co.,Ltd
Clean Energy Company

http://www.sanyo.co.jp/clean/solar/hit_e/index_e.html
email: homepage_solar@sanyo.com



Hispano Energías Verdes
Suministro de módulos solares fotovoltaicos
Suppliers of solar photovoltaic modules
www.energiasverdes.com